

NEMA14-02

schematical drawings

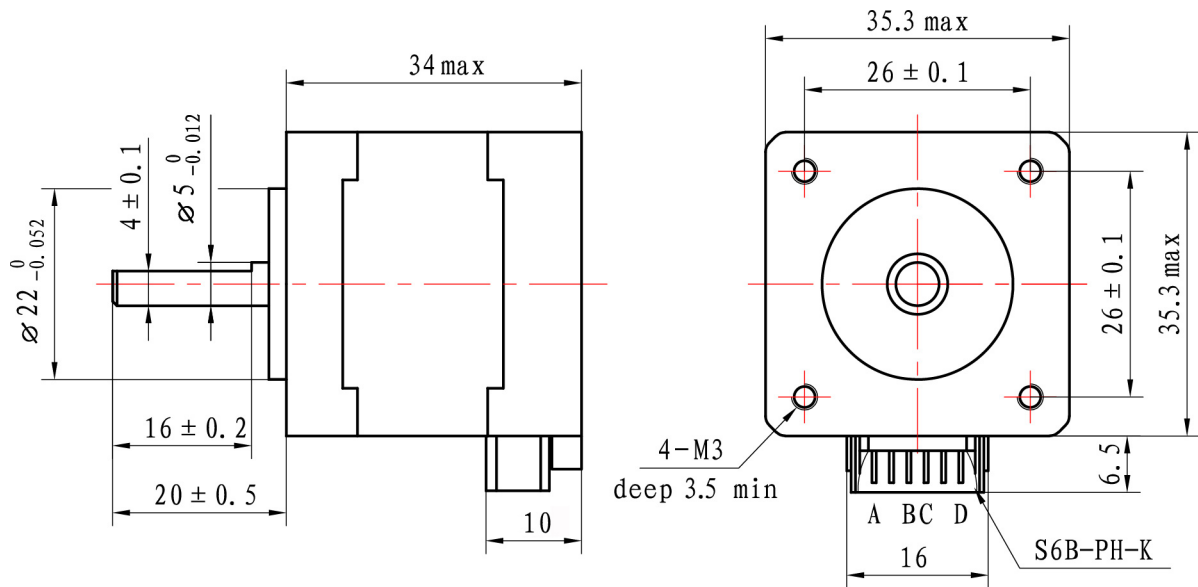

Wiring diagram

