

NEMA17-03

Schematische Zeichnungen

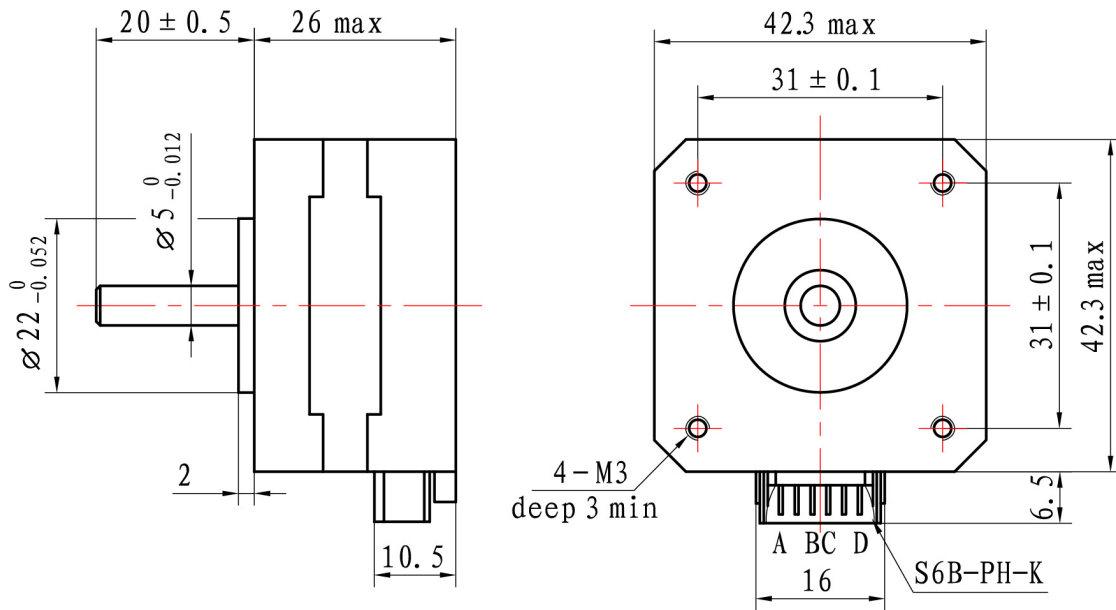

Wiring diagram

