

NEMA17-04

Schematische Zeichnungen

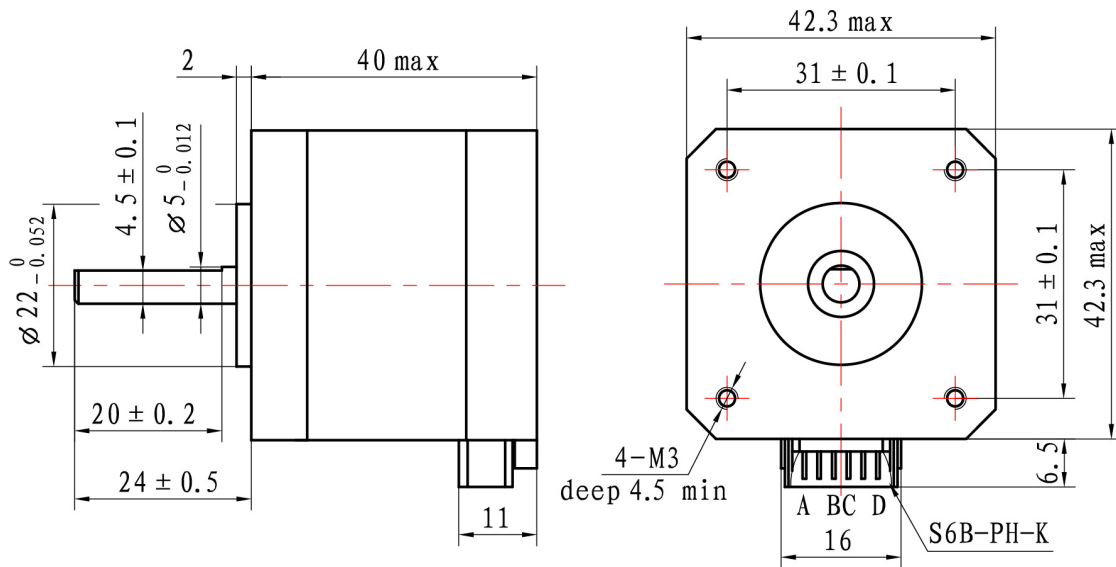

Wiring diagram

